

SEM320 USER GUIDE

HART HEAD MOUNT TEMPERATURE TRANSMITTER WITH DISPLAY
TWO WIRE (4 to 20) mA OUTPUT

Important - Please read this document before installing.

Every effort has been taken to ensure the accuracy of this document; however, we do not accept responsibility for damage, injury, loss or expense resulting from errors and omissions, and we reserve the right of amendment without notice.

IMPORTANT - CE & SAFETY REQUIREMENTS

Product must be mounted inside a suitable enclosure providing environmental protection to IP65 or greater.

To maintain CE EMC requirements, input wires must be less than 3 metres.

The product contains no serviceable parts, or internal adjustments. No attempt must be made to repair this product. Faulty devices must be returned to supplier for repair.

This product must be installed by a qualified person. All electrical wiring must be carried out in accordance with the appropriate regulations for the place of installation.

Before attempting any electrical connection work, please ensure all supplies are switched off.

ABSOLUTE MAXIMUM CONDITIONS (To exceed may cause damage to the device).	
Supply Voltage	± 30 V dc (Protected for over-voltage and reverse connection)
Current with over-voltage	± 100 mA
Input Voltage	± 3 V between any terminals
Ambient	Temperature (-40 to 85) °C, Humidity (10 to 95) % RH (Non-condensing)

Important - Please read this document before any installing.

1~DESCRIPTION.

The device is a universal in-head HART transmitter with display that converts the sensor output(s) over a configured range to a standard industrial (4 to 20) mA transmission signal.

The product is a HART generic device so does not need a specific HART file. Simple HART commands can be performed using a handheld programmer; advanced commands are entered using the PC USB configuration module and software; refer to sales@status.co.uk

Calibration set up may be saved as a file on the PC for later use. If required, the desired range can be specified at the time of order, removing the need for user configuration.

2~RECEIVING AND UNPACKING.

Please inspect the packaging and instrument thoroughly for any signs of transit damage. If the instrument has been damaged, please notify your supplier immediately.

3~SPECIFICATION.

Refer to data sheet for full specification.

Configuration	
Factory default	Pt100, (0 to 100) °C, upscale burnout, 0.0°C offset

4~INSTALLATION AND WIRING.

4~1 MECHANICAL.

The display device is mounted using a three-pin plastic module support suitable for fitting into a suitable connection head. The module support is secured into the head with screws.

The orientation of the display can be adjusted as required by rotating the display in the module support. Care must be taken to avoid over-stressing any wiring.

The display must be installed with adequate protection from moisture and corrosive atmospheres. The device must be located so the ambient temperature does not exceed the specified operating temperature of the device.

4~2 ELECTRICAL.

Electrical connections are made to the two-part screw terminals provided on the back of the device. The transmitter is protected against reverse connection and

over-voltage. If no sensor (input) connection is made, the transmitter will go into either up or down scale output current, depending on configuration setting.
TURN OFF SUPPLY BEFORE WORKING ON ANY ELECTRICAL CONNECTION

For a wiring diagram, please refer to the rear panel of the device inside the case housing, and this document.

Two-part connectors are used for input and output connections, allowing the device to be easily removed if required.

Figure 1: Rear panel layout

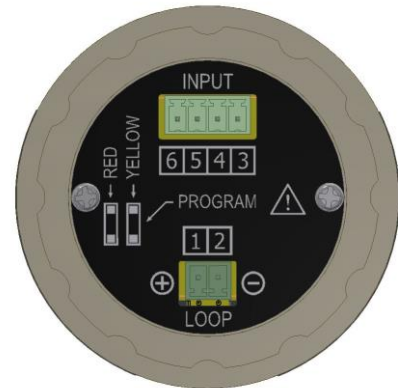

Input sensor connections.

Figure 2: Input connections

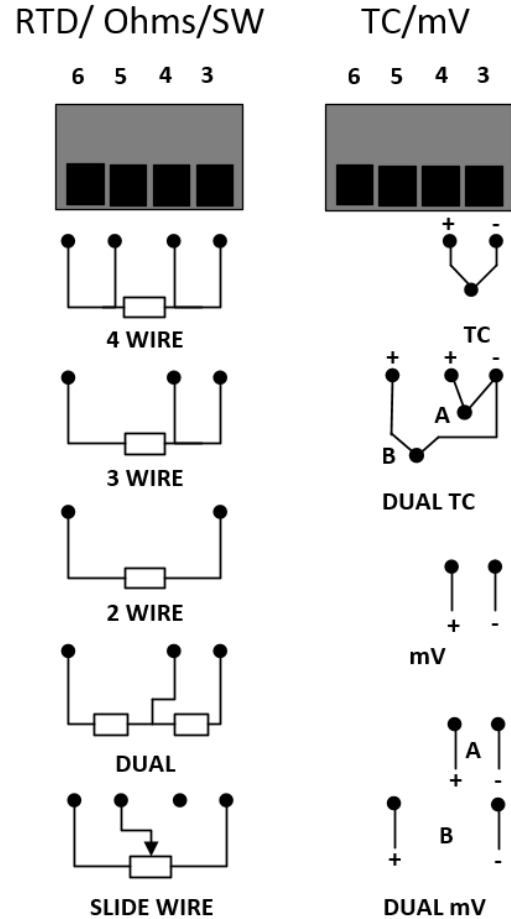

RTD input wires must be equal length and type.

Sensor connections are as figure 2: to maintain BS EN61326 compliance, sensor wires must be less than 3 metres. All sensor connections must be isolated from ground.

For RTD dual input use two wire RTDs. If required, user-offsets can be done on both inputs to known input values.

Thermocouple inputs must use correct compensation cable.

Sensor connections are as figure 2: to maintain BS EN61326 compliance, sensor wires must be less than 3 metres. All sensor connections must be isolated from ground.

For dual thermocouple input, both thermocouples must be of the same type. If required, user-offsets can be done on both inputs to known input values.

4~2 ELECTRICAL (Continued).

(4 to 20) mA Loop connections.

Ensure all other aspects of the installation comply with the requirements of this document. To maintain CE compliance, the (4 to 20) mA current loop must be tied to a local earth at one point; this is normally at the power supply.

Use twisted pair or screened cables for cable lengths greater than 3 metres. Maximum cable length 1000 metres.

5~USER CONFIGURATION.



IMPORTANT

READ COMPLETE SECTION BEFORE ATTEMPTING CONFIGURATION.

WARNING

For configuring or reading live data if using a grounded input or output, it is important not to connect the programming USB lead to a mains powered computer. It is possible to damage the instrument if connected in this way.

To avoid damage, use one of the following methods:

- Disconnect the input and output connectors before configuration, reconnect the connectors after configuration.
- Use a laptop-type computer running from its battery power supply, not connected to a mains supply. This is recommended for reading live device data or offsetting a device if already installed in the field.
- Use a USB isolator between the computer and the device.

DISPLAY: The display provides five 7-segment characters for display of value and 5 14-segment characters for messages, together with a 10-segment bar graph, % of output signal display and five icons. The display is capable of operating in an ambient temperature range of (-20 to 85) °C, but at temperatures lower than -5 °C (due to the slower LCD speed) scrolled messaging is not practical.

The display's high contrast offers clear readouts at low as well as high ambient light and direct sunlight.

The display layout is as follows:

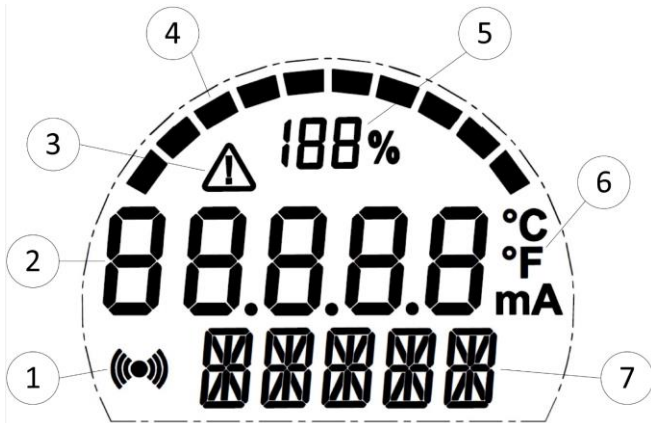

Figure 3: Display layout.

1. Indicated HART communications
2. Main numeric value display
3. Signal out-of-range warning icon
4. Bar graph of output
5. % of output
6. Bespoke °C and °F temperature indication devices (mA not used) display.

Use this space for configuration notes if required.

5~1 USBSpeedLink USER CONFIGURATION

A USB configuration module is required for connecting the device to the PC. Refer to your supplier for details.

The device can be configured whilst connected and powered but a portable battery powered computer must be used to avoid the effects of ground loops if the (4 to 20) mA loop is grounded. This may cause damage to the display device.

Figure 4: Configuration connection.

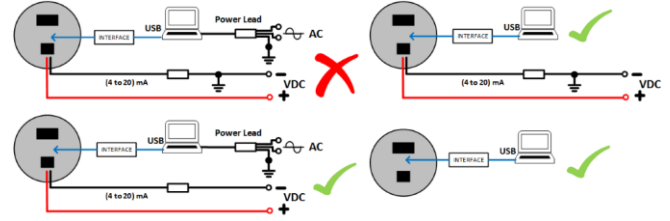

Install the software and connect the USB configuration module

Configuration steps	
1	Install the software and connect the USB configuration module to the PC.
2	Remove the rear panel cover held by two screws (see figure 1)
3	Connect the configuration module to the device (observe orientation).
4	Select the correct programming page in the software.
5	Read the device configuration into the software.
6	Re-configure or adjust configuration options as required.
7	Send the new configuration to the device.

Configuration options in USBSpeedLink software

Sensor tab	
Input type	RTD (type, No. of wires), T/C (type), Ohms, Slide-wire, mV Single input, dual input (with maths).
Sensor offset	In engineering devices, can be entered for probe/system correction
Burn out	Any value in input devices to control device behaviour on input fail
Sensor pre-set	An internal "simulated" value can be applied to the input of the device for diagnostics

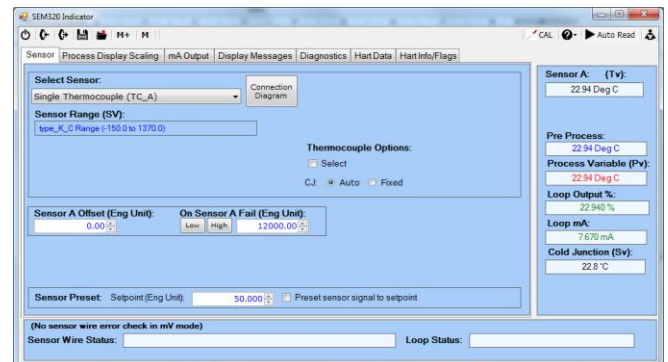

Process display scaling tab	
Mode Off	Normal use for °C temperature inputs
Mode Scale	Select for °F, process and dual inputs
Mode Profile	Gives 22-segment user-linearisation tool for custom input to output relationship. Can be used to apply probe corrections at up to 22 points.
Display decimal place	Used to set the required number for the display

mA output tab	
Damping	Seconds to reach 76% of final value
Low mA	Engineering value to give 4 mA output
High mA	Engineering value to give 20 mA output
Fixed loop	The device can be set to give a pre-set mA output. The device will return to normal operation after a power reset, for diagnostics.
Current limits	Can be used to set the minimum and maximum current values the device can output. Useful for defining burnout condition.
Namur 43 standard	Burnout control, on or off

5~1 USBSpeedLink USER CONFIGURATION (continued)

Display messages tab	
Range	Use to set up to 6 defined temperature/process bands that can have fixed or custom messages assigned to them. The display will show the messages in turn, with the input value, when within the selected band.
Message	Define up to 6 custom messages that can be displayed when the input value is within pre-set bands
MsgA, MsgB	Sets which messages are displayed for each band
Bar and %	Selects whether to show the % of input range bar and the % of input range value on the screen

Diagnostic tab	
Operation data	Will display: Maximum and minimum values since last reset Operational time from manufacture Operational time from calibration Calibration date
Cal cert number	Free type field saved to the device
Calibrated by	Free type field saved to the device
Save transducer	Will save the configuration manifest to a text file on the PC

HART data tab	
Tag number	HART specified; free type field saved to the device
Date	HART specified; saved to the device
Description	HART specified; free type field saved to the device
Message	HART specified; free type field saved to the device
Final Assembly	HART specified; number saved to the device
Long tag	HART specified; free type field saved to the device
Transducer number	HART specified; number saved to the device
Write protect	HART write protect: On, Off
Read HART	
Transducer	ID
Configuration counter	Number of changes made via HART communications

HART information tab	
HART information flags	On, Off, see below

HART information flags

Sensor		Process Display Scaling		mA Output		Display Messages		Diagnostics		Hart Data		Hart Info/Flags																																																					
<table border="0"> <tr> <td>Device Malfunction:</td> <td>Extended Device Status:</td> </tr> <tr> <td>Device Malfunction: ●</td> <td>Not Defined: ●</td> </tr> <tr> <td>Config Change: ●</td> <td>Not Defined: ●</td> </tr> <tr> <td>Cold Start: ●</td> <td>Not Defined: ●</td> </tr> <tr> <td>More Status Available: ●</td> <td>Not Defined: ●</td> </tr> <tr> <td>Loop Fixed: ●</td> <td>Sensor Isolated, Signal (TV) Fixed: ●</td> </tr> <tr> <td>mA Output Saturated: ●</td> <td>Outside Ambient Temperature Range: ●</td> </tr> <tr> <td>SV or TV outside Range: ●</td> <td>Device Variable Alert: ●</td> </tr> <tr> <td>PV outside Range: ●</td> <td>Maintenance Required (Not Supported): ●</td> </tr> <tr> <td></td> <td></td> <td style="text-align:right">● = On</td> <td style="text-align:right">● = Off</td> </tr> </table>														Device Malfunction:	Extended Device Status:	Device Malfunction: ●	Not Defined: ●	Config Change: ●	Not Defined: ●	Cold Start: ●	Not Defined: ●	More Status Available: ●	Not Defined: ●	Loop Fixed: ●	Sensor Isolated, Signal (TV) Fixed: ●	mA Output Saturated: ●	Outside Ambient Temperature Range: ●	SV or TV outside Range: ●	Device Variable Alert: ●	PV outside Range: ●	Maintenance Required (Not Supported): ●			● = On	● = Off																														
Device Malfunction:	Extended Device Status:																																																																
Device Malfunction: ●	Not Defined: ●																																																																
Config Change: ●	Not Defined: ●																																																																
Cold Start: ●	Not Defined: ●																																																																
More Status Available: ●	Not Defined: ●																																																																
Loop Fixed: ●	Sensor Isolated, Signal (TV) Fixed: ●																																																																
mA Output Saturated: ●	Outside Ambient Temperature Range: ●																																																																
SV or TV outside Range: ●	Device Variable Alert: ●																																																																
PV outside Range: ●	Maintenance Required (Not Supported): ●																																																																
		● = On	● = Off																																																														
<table border="0"> <tr> <td colspan="4">Hart Device Specification:</td> </tr> <tr> <td>Manufacturers ID</td> <td>24</td> <td>Max No. Variables</td> <td>4</td> <td>Device Profile</td> <td>1</td> </tr> <tr> <td>Short Device ID</td> <td>EF</td> <td>Config Change Count</td> <td>0</td> <td>Device ID (1)</td> <td>00</td> </tr> <tr> <td>Hardware Revision</td> <td>7</td> <td>Extended Device Status</td> <td>6</td> <td>Device ID (2)</td> <td>00</td> </tr> <tr> <td>Device Revision</td> <td>1</td> <td>Extended Manufacturers ID</td> <td>EF</td> <td>Device ID (3)</td> <td>01</td> </tr> <tr> <td>Software Revision</td> <td>3</td> <td>Extended Distribuer ID</td> <td>EF00</td> <td></td> <td></td> </tr> <tr> <td>Hardware Revision</td> <td>1</td> <td></td> <td></td> <td>No. of Preambles Response</td> <td>5</td> </tr> <tr> <td>Unique ID</td> <td>84EF001</td> <td></td> <td></td> <td></td> <td></td> </tr> <tr> <td>No. of Preambles Request</td> <td>5</td> <td></td> <td></td> <td></td> <td></td> </tr> </table>														Hart Device Specification:				Manufacturers ID	24	Max No. Variables	4	Device Profile	1	Short Device ID	EF	Config Change Count	0	Device ID (1)	00	Hardware Revision	7	Extended Device Status	6	Device ID (2)	00	Device Revision	1	Extended Manufacturers ID	EF	Device ID (3)	01	Software Revision	3	Extended Distribuer ID	EF00			Hardware Revision	1			No. of Preambles Response	5	Unique ID	84EF001					No. of Preambles Request	5				
Hart Device Specification:																																																																	
Manufacturers ID	24	Max No. Variables	4	Device Profile	1																																																												
Short Device ID	EF	Config Change Count	0	Device ID (1)	00																																																												
Hardware Revision	7	Extended Device Status	6	Device ID (2)	00																																																												
Device Revision	1	Extended Manufacturers ID	EF	Device ID (3)	01																																																												
Software Revision	3	Extended Distribuer ID	EF00																																																														
Hardware Revision	1			No. of Preambles Response	5																																																												
Unique ID	84EF001																																																																
No. of Preambles Request	5																																																																

With a device connected to the configuration module, the software can display some live data readings. The sections to the right-hand side and the bottom of the screen are used.

Live data reading	
Sensor A	Input value
Sensor B	Input value
Pre-process	Pre-maths input value
Process variable	Post-maths input value
Loop output %	Loop output as a % of range
Loop mA	Loop output in mA
Cold junction	Temperature of the cold junction
Sensor wire	Error detection for input wiring
Loop	Error detection for loop wiring

USBSpeedLink menu buttons

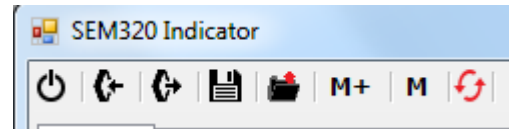

Menu button Icons from left to right

Exit: Close the program

Send configuration <: Will send the current screen configuration to the device connected.

Retrieve configuration >: Will load the configuration from the connected device into the screen of the USBSpeedLink software.

Save: Saves the current screen configuration to a PC file for back-up.

Load: Recalls a backed-up configuration file from the PC.

M+: Saves the current screen configuration to a temporary memory file.

M: Recalls the temporary memory configuration to the screen.

Circular red arrows: Will show to indicate that the screen and the configuration on the device do not match and will need to be synchronised with either a read or a write command.

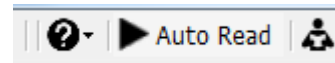

Menu button icons from left to right

?: Opens the USBSpeedLink help files

>Auto read: Will start consecutive live data readings, this can be time adjusted. The data values will be displayed on screen.

Read: Will take a single live data reading to be displayed on screen.

5~2 HART USER CONFIGURATION

The SEM320 has HART communications. The SEM320 is a generic HART device. For a list of implemented HART commands please refer to the data sheet.

Connection is as shown below. A suitable load resistor (250 Ohm) must be used in the loop.

Figure 5: Connection arrangement for HART communications

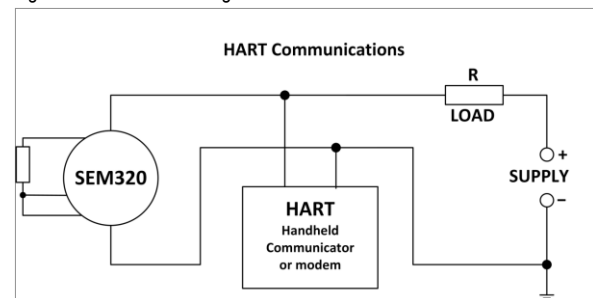

The SEM320 can be used in HART multi-drop mode. Each device must be given a unique address; this can be done using a HART communications device or with the USBSpeedLink software.

Figure 6: Connection arrangement for HART multi drop communications

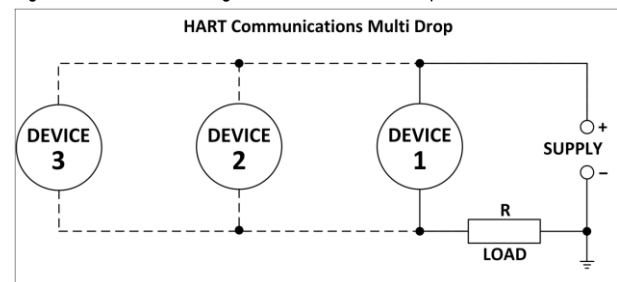

For more information on the HART protocol, refer to the Fieldcomm group website <https://fieldcommgroup.org/>

6~CONFIGURATION EXAMPLES

Example ~1: Change from °C to °F range

The SEM320 will default to work in °C for temperature measurement. It may be desired to work in °F or K

Change a °C to a °F range		
1	Sensor Tab	Set input type, sensor fail value
2	Process Display Tab	Select the "Scale" radio button On the temperature range Wizard select "°F"
3	mA Output Tab	Set the output range, in °F

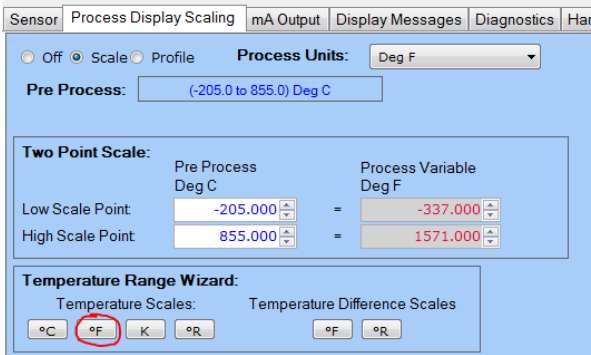

Example ~2: Using the profile tool.

The SEM320 has a profiling tool that can be used to create custom configurations. This can be used in many ways such as linearising a slide-wire level sensor to volume on non-linear tanks, or temperature probe/system calibration corrections.

1) A Pt100 probe has been calibrated with a SEM320 display and found to have the following characteristics:

Temperature °C	Display °C
0.00	-0.05
25.00	25.55
50.00	51.08
100.00	101.40

This can be entered as a correction using the profile tool:

Probe calibration corrections using the profile tool		
1	Sensor Tab	Set input type, sensor fail value
2	Process Display Tab	Select the "Profile" radio button Set the number of points required Enter the profile in ascending order with the recorded values in the first column and the corrections in the second column.
3	mA Output Tab	Set the output range



2) A non-linear tank volume 10 k litre monitored by a slide-wire sensor can be entered as shown in the example below:

Non-linear slide-wire tank volume in litres using the profile tool		
1	Sensor Tab	Set input type, sensor fail value
2	Process Display Tab	Select the "Profile" radio button Change the process unit to "L" Set the number of points required Enter the profile in ascending order with the input values in the first column and the process values in the second column.
3	mA Output Tab	Set the output range

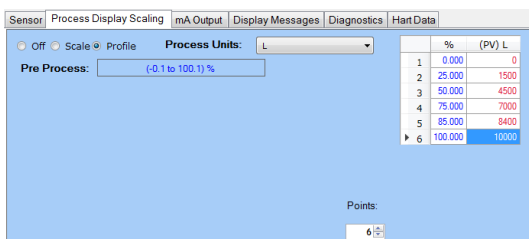

Example ~3: Display Messages

The SEM320 has a lower display for rolling messages and engineering unit display, see section 5~ Figure 3, Item 7.

A set of custom messages can be displayed on the SEM320 over pre-defined ranges. One (Msg A) or two (Msg A + Msg B) messages can be applied to each range.

Custom message display		
1	Display Messages Tab	Use the table on the left to set up the boundaries for the ranges.
2		Use the drop-down selections to set which messages are applied to the ranges.
3		Use the text boxes on the right to create the required message.

In the set up below, the following messages would show on the lower rolling display:

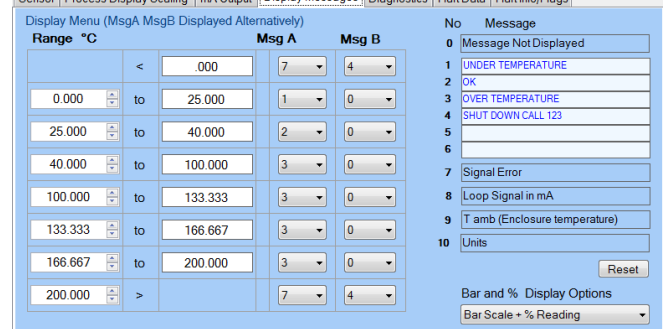

Below 0°C "SIGNAL ERROR" + "SHUT DOWN CALL 123"
 (0 to 25) °C "UNDER TEMPERATURE"
 (25 to 40) °C "OK"
 (40 to 100) °C "OVER TEMPERATURE"
 (100 to 133) °C "OVER TEMPERATURE"
 (133 to 166) °C "OVER TEMPERATURE"
 (166 to 200) °C "OVER TEMPERATURE"
 Above 200°C "SIGNAL ERROR" + "SHUT DOWN CALL 123"

The lower display can also be set to display the output current in mA and the temperature of the cold junction of the device (even when not configured for a thermocouple input)



Status Instruments Ltd, Status Business Park, Gannaway Lane, Tewkesbury,
 Gloucestershire, UK, GL20 8FD
 Web Page: www.status.co.uk
 Email: sales@status.co.uk
 Technical Support: support@status.co.uk
 Tel: +44 (0) 1684 296818, Fax: +44 (0) 1684 293746