

SEM1620 USER GUIDE

DIN RAIL MOUNTED CONDITIONER
 UNIVERSAL INPUT
 THREE WIRE VOLTAGE OUTPUT

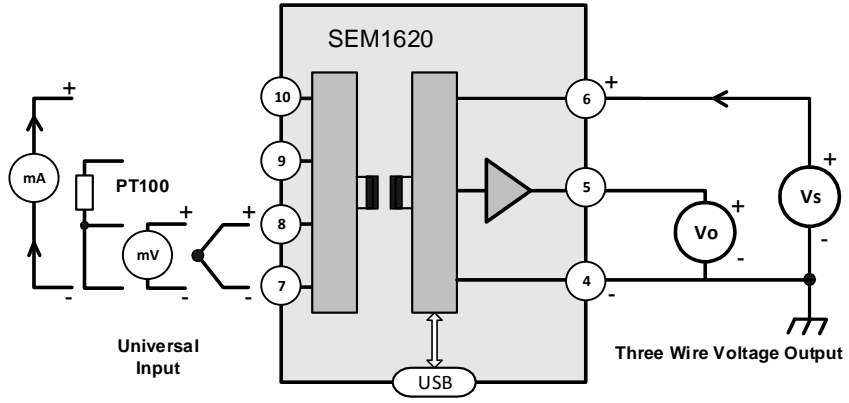

Important – Read this document before installing.



Every effort has been taken to ensure the accuracy of this document, however we do not accept responsibility for damage, injury, loss or expense resulting from errors and omissions, and we reserve the right of amendment without notice.

IMPORTANT - CE, UKCA & SAFETY REQUIREMENTS

- Product must be DIN rail mounted, inside a suitable enclosure providing environmental protection to IP65 or greater.
- To maintain CE EMC requirements, input and supply wires must be less than 30 metres.
- Dc supply must be derived from a local supply and not a distribution system.
- The product contains no serviceable parts, or internal adjustments. no attempt must be made to repair this product. Faulty units must be returned to supplier for repair.
- This product must be installed by a qualified person. All electrical wiring must be carried out in accordance with the appropriate regulations for the place of installation.
- Before attempting any electrical connection work, please ensure all supplies are switched off.

ABSOLUTE MAXIMUM CONDITIONS (To exceed may cause damage to the unit):-

Supply Voltage	± 30 V dc (Protected for over voltage and reverse connection)
Current with over voltage	± 200 mA
Input Voltage	± 5 V between any terminals
Input Current	± 100 mA between terminals 7 & 10
Ambient	Temperature (-30 to 75) °C Humidity (10 to 95) % RH (Non condensing)

PRODUCT SPECIFICATION

Please refer to the product data sheet for full specification, available to download at www.status.co.uk.

RECEIVE AND UNPACKING

Please inspect the packaging and instrument thoroughly for any signs of transit damage. If the instrument has been damaged, please notify your supplier immediately.

CONFIGURATION



IMPORTANT The SEM1620 can be configured whilst connected and powered, but a portable battery powered computer must be used to avoid the effects of ground loops.

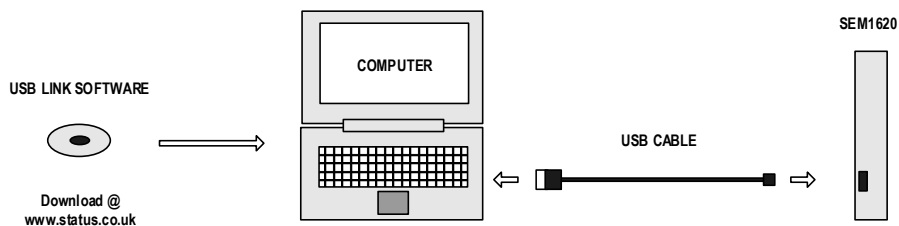

The following parameter can be configured by simply entering as prompted by the software package.

- Input type (K,J,E,N,T,R,S,mV,PT100,mA)
- Low range
- High range
- Units (°C, °F, mV, mA)
- Burnout (direction of output current on sensor burnout)
- Output Range (0 to 10), (0 to 5), (0 to 1), (1 to 5), and (2 to 10) V
- User Adjust (option to lock out front panel adjust function)

Factory default:

Input type	= P
Units	= °C
High Range	= 100
Low Range	= 0
Burnout	= UPSCALE
Output range	= (0 to 10) V
User Adjust	= ON

MECHANICAL INSTALLATION

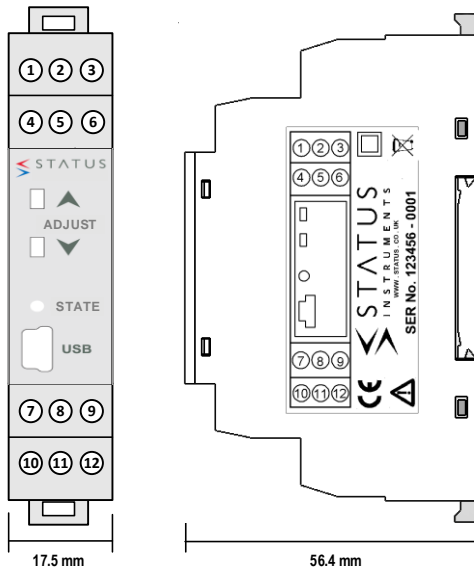

MOUNTING

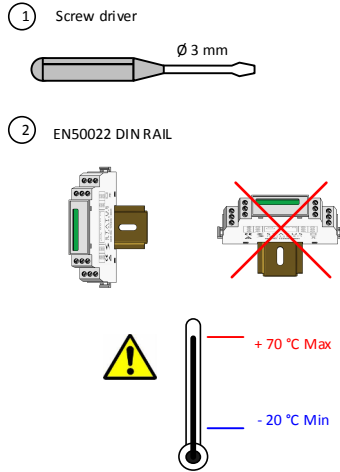

SEM1620 Enclosure

Style	DIN 43880 (1 module width)
Material	Polyamide 6.6 self extinguishing
Terminals	Screw terminal
Cable	2.5 mm Max
Colour	Grey

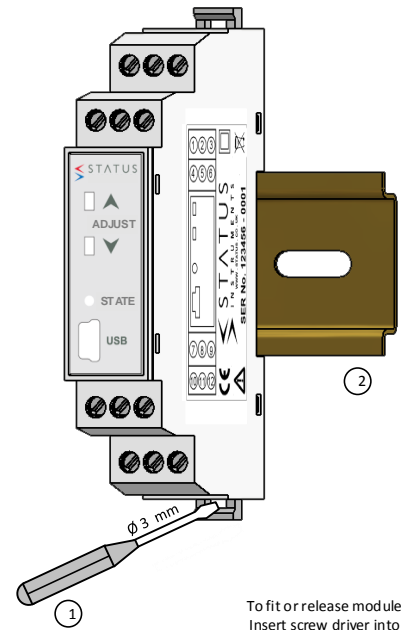

To fit or release module
Insert screw driver into slot and lever latch away from body

ELECTRICAL INSTALLATION

Screened Cable



Twisted Pair Cable



TC Compensation Cable Screened



Screw Driver

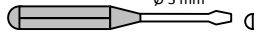

TURN OFF SUPPLY BEFORE WORKING ON ANY ELECTRICAL CONNECTION

UNIVERSAL INPUT CONNECTION

For cable length < 3 Metres no screen or twist pair required. Thermocouple inputs must use correct compensation cable. PT100 inputs all three wire must be equal length (resistance). Use recommended types for cable length (3 to 30) metres.

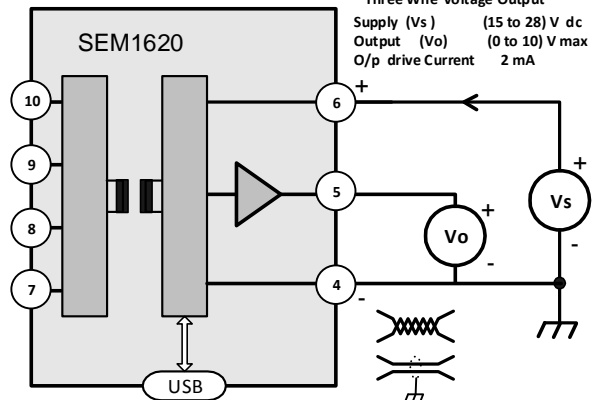
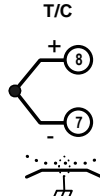
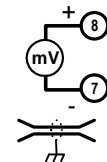
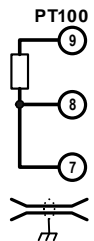
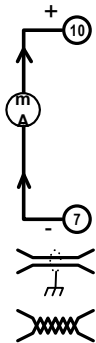

OUTPUT
Three wire voltage
Max cable length 30 metres
Use twisted pair cable or screened > 3 metres

USER TRIM

Screw Driver

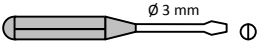

Digital Voltage meter



Power supply (24 V dc)

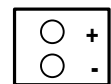

Input Simulator

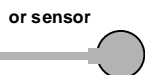
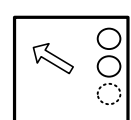

User adjust function allows manual adjustment of the output current, this is useful for minor calibration adjustment or trimming out any sensor error, $\pm 5\%$ of range adjustment is available at both offset and span. Raise and lower buttons are provided on the front panel, of the conditioner, accessed using a 3 mm flat blade screw driver. Insert the screw driver into the appropriate slot to operate the button. The button has a click action.

The conditioner will automatically detect the correct trim point (offset or span) based on the output current drive. Offset will be adjusted when the output voltage is within ± 0.1 V of offset output, span when the output voltage is within (50 to 105) % of output range.

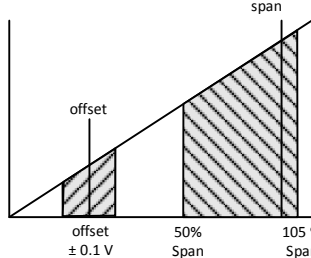

METHOD

1.0 Connect input simulator or sensor. Connect supply to a 24 V dc, connecting a digital volt current meter to output. Turn supply on, set input to either offset or span calibration point.

2.0 Enter trim menu by pressing "raise" button for > two seconds. When the adjust menu is open the state LED will flash :-

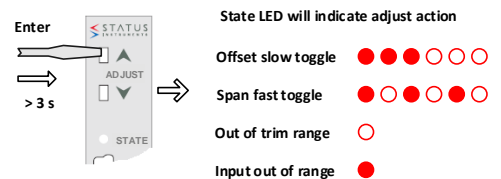

3.0 Adjust output voltage by pressing either the raise or lower button, single click to step advance, or press continuously to auto advance.

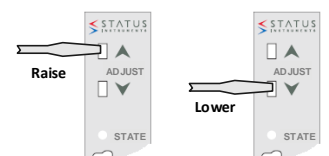

4.0 Once adjust is complete allow 30 seconds with no button press, the conditioner will time out and return to normal operation.

